

**INTEGRITY
RESPONSIBILITY
HARMONY
INNOVATION**

Integrity, responsibility, harmony, innovation

Creating first-class quality Pursuing customer satisfaction



ADDRESS: AV. DE LOS METALES, 14A, 28914, LEGANÉS, MADRID, SPAIN



EMAIL: INFO@GANLIFT.COM



WEBSITE: [HTTPS://GANLIFT.COM/](https://GANLIFT.COM/)



GAN

TIANHONG MACHINERY & ELECTRIC

GAN ELECTROMECHANICA, S.L.

**INTEGRITY RESPONSIBILITY
HARMONY INNOVATION**

**Creating first-class quality
Pursuing customer satisfaction**

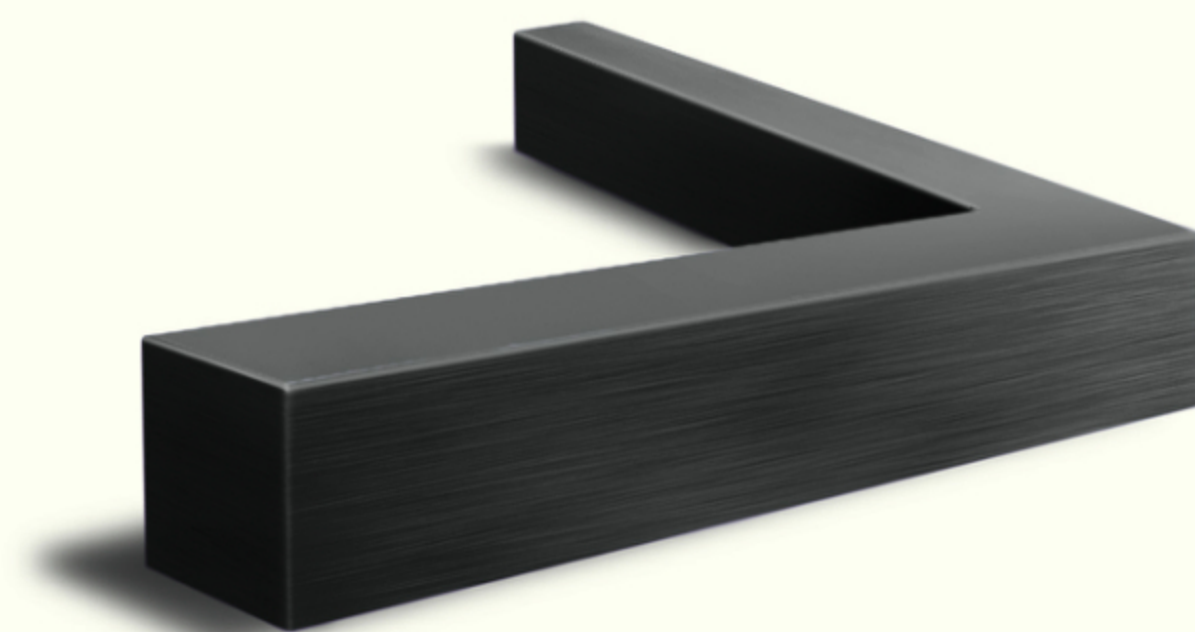

▶ ENTERPRISE INTRODUCTION

GAN ELECTROMECHANICA, S.L. IS A SPECIALIZED COMPANY IN THE SALES, INSTALLATION, MODIFICATION, AND MAINTENANCE OF ELEVATORS. OUR HEADQUARTERS ARE LOCATED IN GANZHOU, JIANGXI, CHINA. WITH OVER 30 YEARS OF EXPERIENCE IN DESIGNING AND SELLING COMPLETE ELEVATORS AND ELEVATOR COMPONENTS WORLDWIDE, WE HAVE ESTABLISHED OUR BRANCH OFFICE IN MADRID, SPAIN TO PROVIDE PROMPT CUSTOMER SUPPORT AND LOCALIZED SERVICES FOR THE EUROPEAN AND AMERICAN MARKETS.

WE ARE RENOWNED FOR DELIVERING HIGH-QUALITY, SAFE, AND RELIABLE ELEVATOR PRODUCTS WHILE OFFERING COMPREHENSIVE SOLUTIONS THAT CATER TO THE VERTICAL TRANSPORTATION NEEDS OF COMMERCIAL COMPLEXES. FROM PRE-SALES TO AFTER-SALES SUPPORT, WE PRIORITIZE CUSTOMER SATISFACTION BY FOCUSING ON COST-EFFECTIVE PRODUCTS THAT COMPLY WITH LOCAL REGULATIONS AND STANDARDS.



▶ THE HEADQUARTERS OFFICE BUILDING IS LOCATED IN GANZHOU, JIANGXI, CHINA

OUR COMMITMENT LIES IN CONTINUOUS INNOVATION AND TECHNOLOGICAL ADVANCEMENTS TO MEET EVOLVING CUSTOMER REQUIREMENTS. OUR EFFICIENT TEAM COMPRISING ENGINEERS, DESIGNERS, AND SALES STAFF PROVIDES EXTENSIVE SUPPORT SERVICES INCLUDING SOLUTIONS FOR RENOVATING OLD ELEVATORS OR INSTALLING NEW ONES IN EXISTING BUILDINGS.

ELECTROMECHANICA

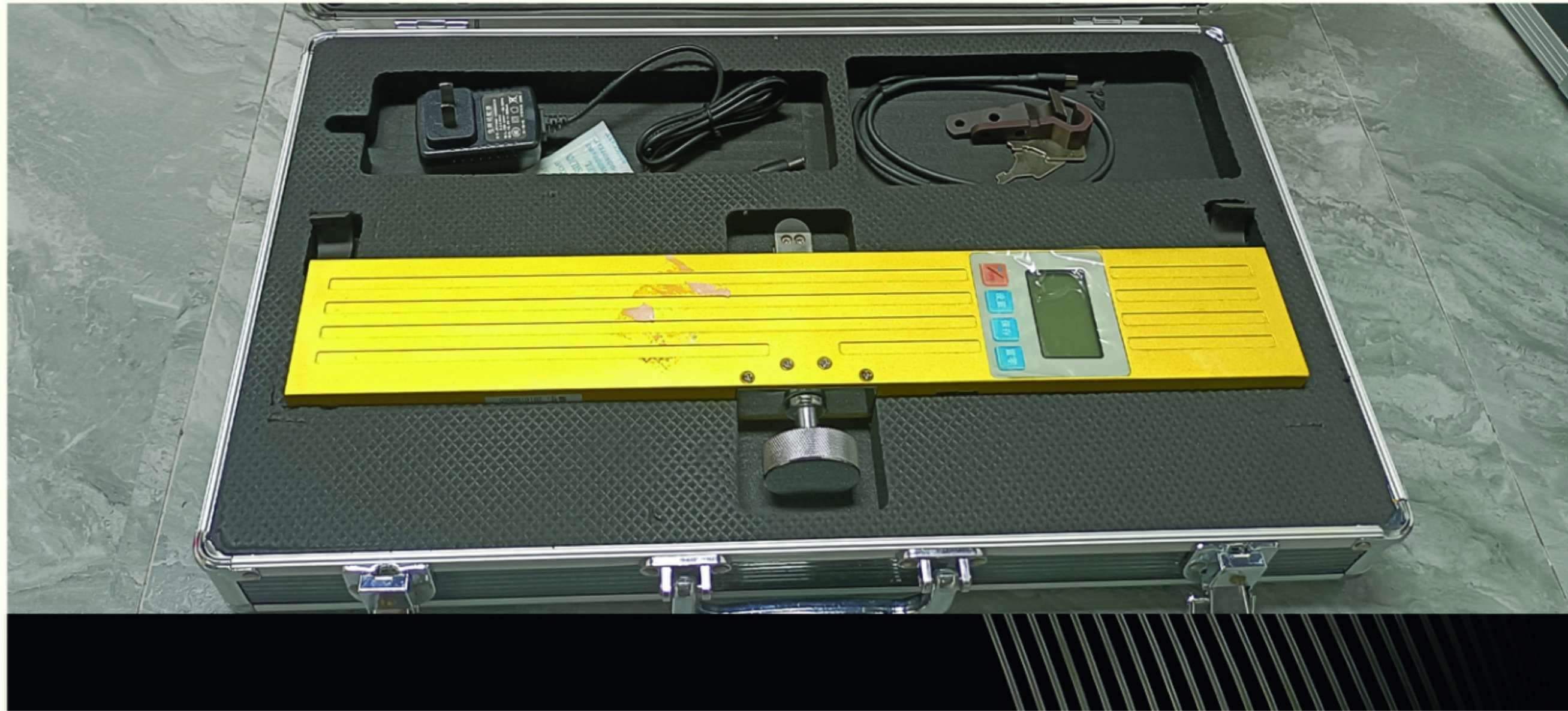

► COOPERATIVE PROJECT

We proudly collaborate with esteemed partners like Shanghai Mitsubishi Elevator Co., Ltd., Hangzhou Olida Elevator Co., Ltd., Suzhou Inovance Technology, and other prominent enterprises within the European and American elevator industry, to deliver exceptional services to our valued customers. Furthermore, we are eager to learn from our counterparts within these industries, together forging ahead towards excellence.

We proudly collaborate with esteemed partners like Shanghai Mitsubishi Elevator Co., Ltd., Hangzhou Olida Elevator Co., Ltd., Suzhou Inovance Technology, and other prominent enterprises within the European and American elevator industry, to deliver exceptional services to our valued customers. Furthermore, we are eager to learn from our counterparts within these industries, together forging ahead towards excellence.



► ELEVATOR CARRYING QUALITY ANALYZER



▶ WIRE ROPE TENSION TESTER



▶ ELEVATOR ACCELERATION AND DECELERATION TESTER



▶ WIRE ROPE FLAW DETECTOR



▶ ELEVATOR CARRYING QUALITY ANALYZER

ADVANCED EQUIPMENT



▶ PUSH-PULL FORCE GAUGE



▶ NOISE METER



▶ BATTERIES



▶ BUFFER



▶ GSM



▶ INSPECTION DEVICE



▶ EMERGENCY



▶ CONTROL CABINET

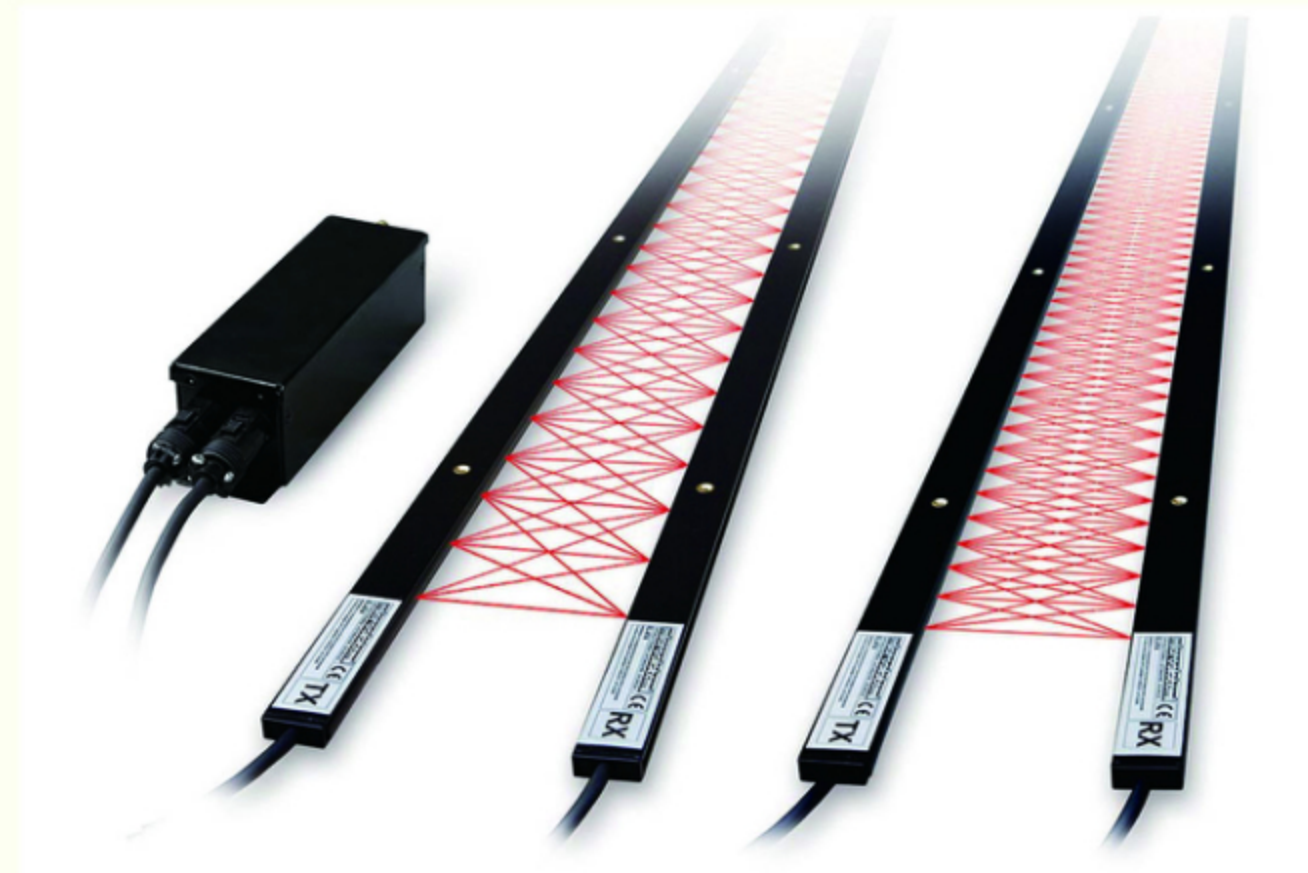

▶ INFRARED CURTAIN



▶ HOIST ROPE



▶ LANDING DOOR (3C)

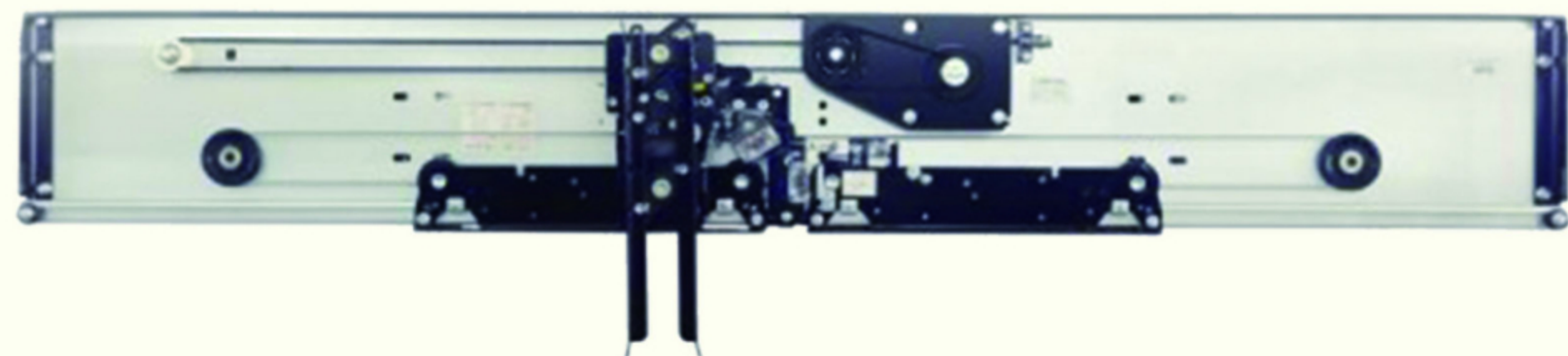

▶ CENTER-OPENING 2 PANELS DOOR OPERATOR



▶ DOOR-OPERATOR-2L-2R

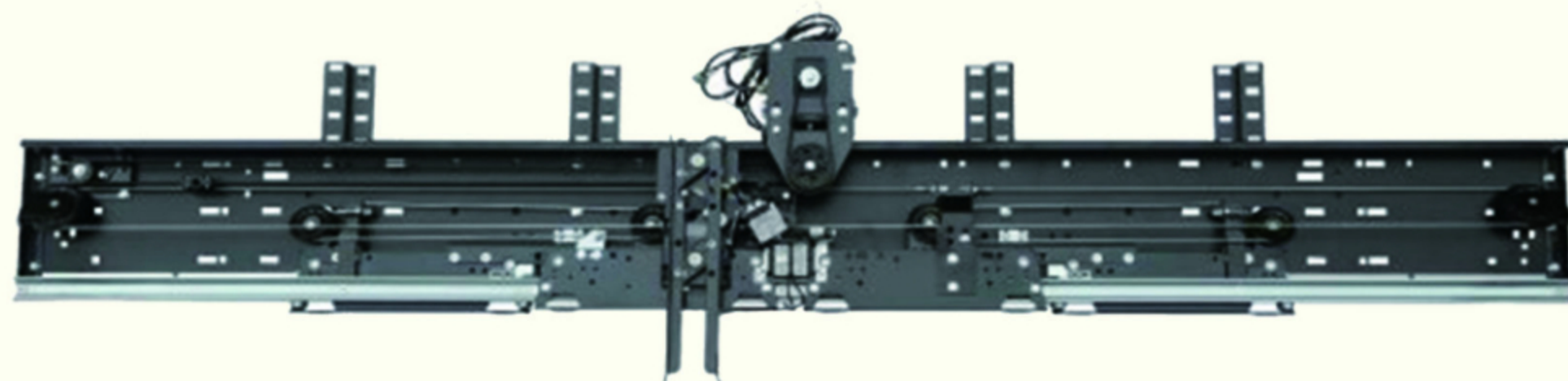

▶ CENTER-OPENING 4 PANELS DOOR OPERATOR



▶ CENTER-OPENING 2 PANELS LAYER DOOR DEVICE

ADVANCED EQUIPMENT



▶ LANDING DOOR (1C)



▶ LANDING DOOR (2L2R)

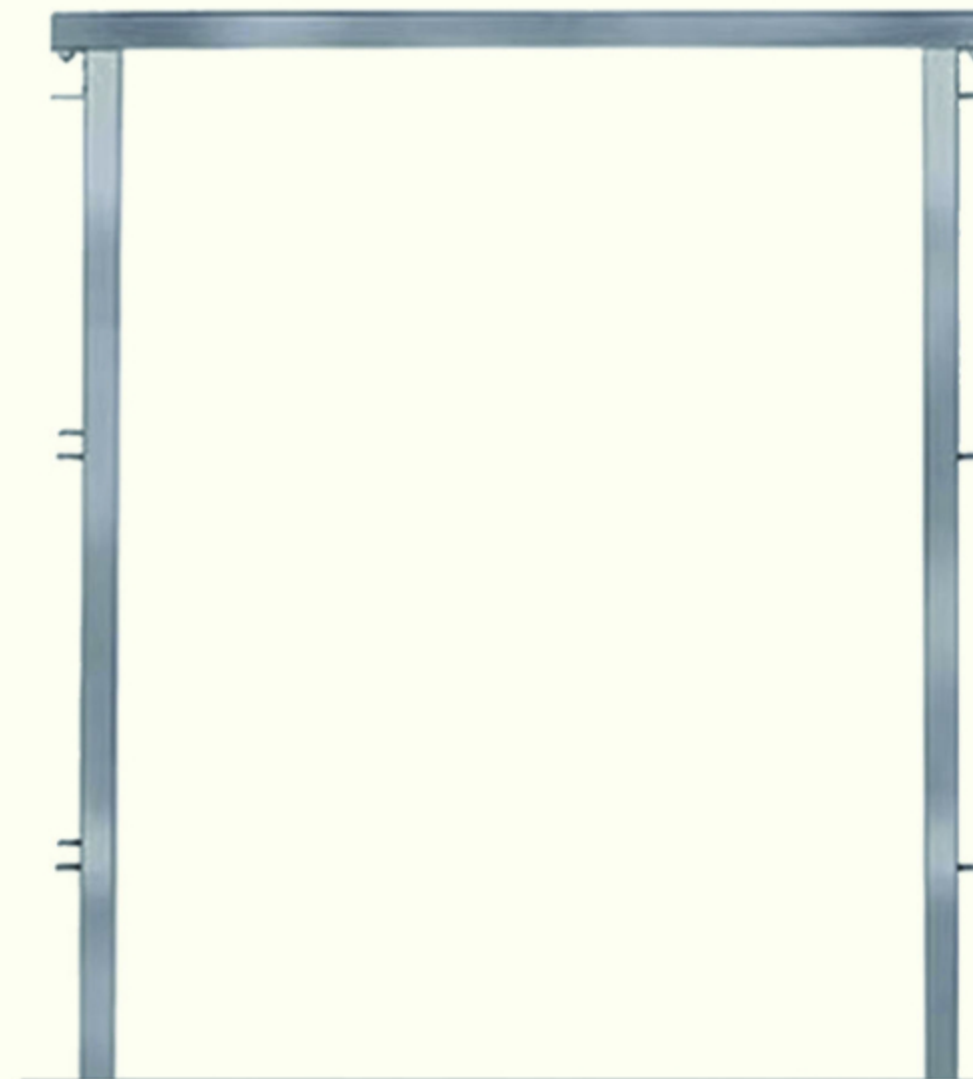

▶ LANDING DOOR JAMB

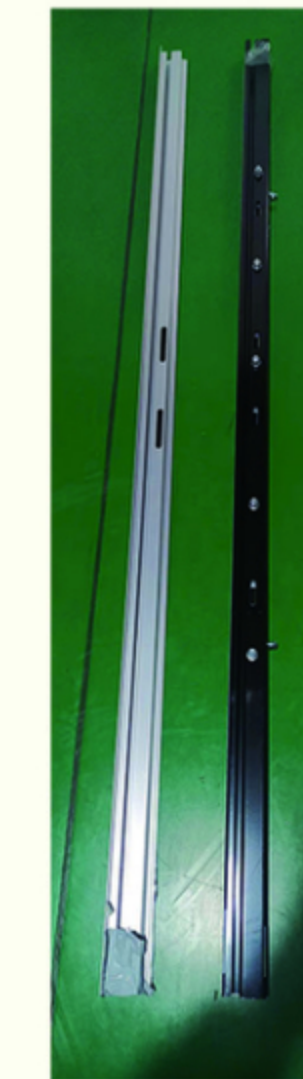

▶ LANDING SILL



▶ MACHINE

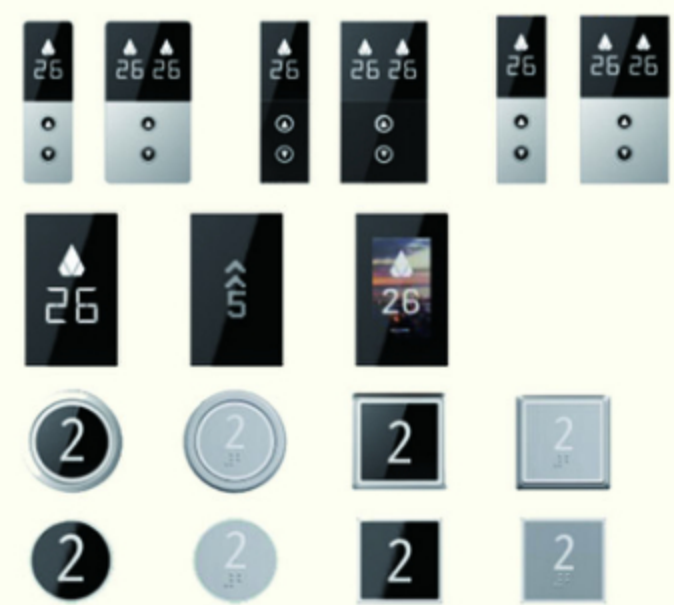

▶ LCI



▶ SIGNALING BUTTONS



▶ LOADWEIGHER



▶ MACHINE1

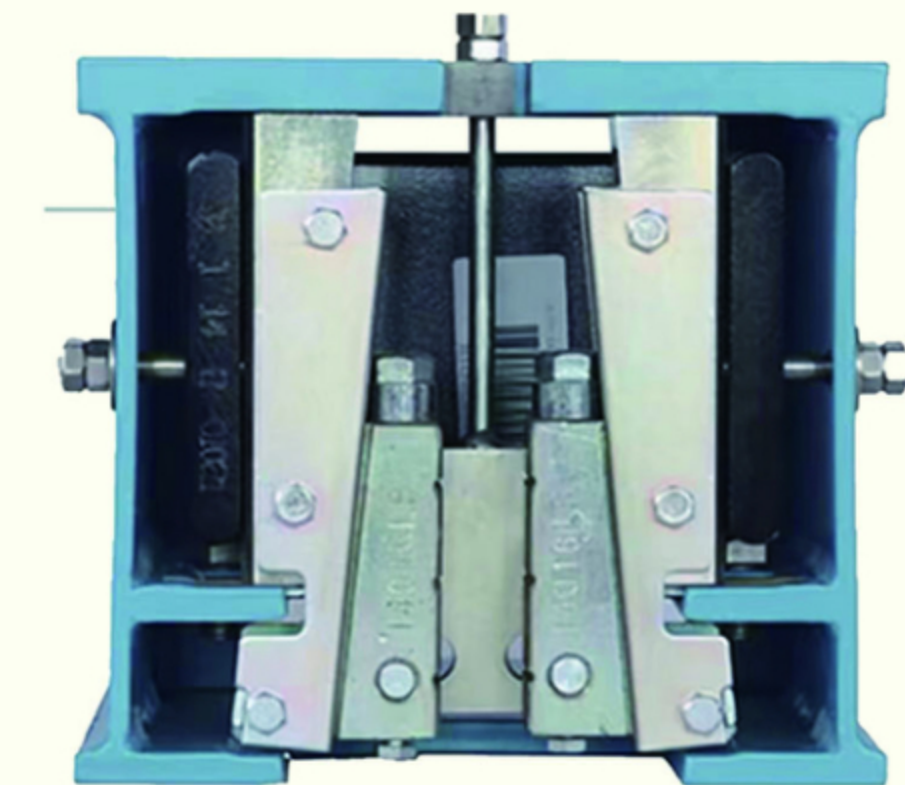

▶ SAFETY GEAR

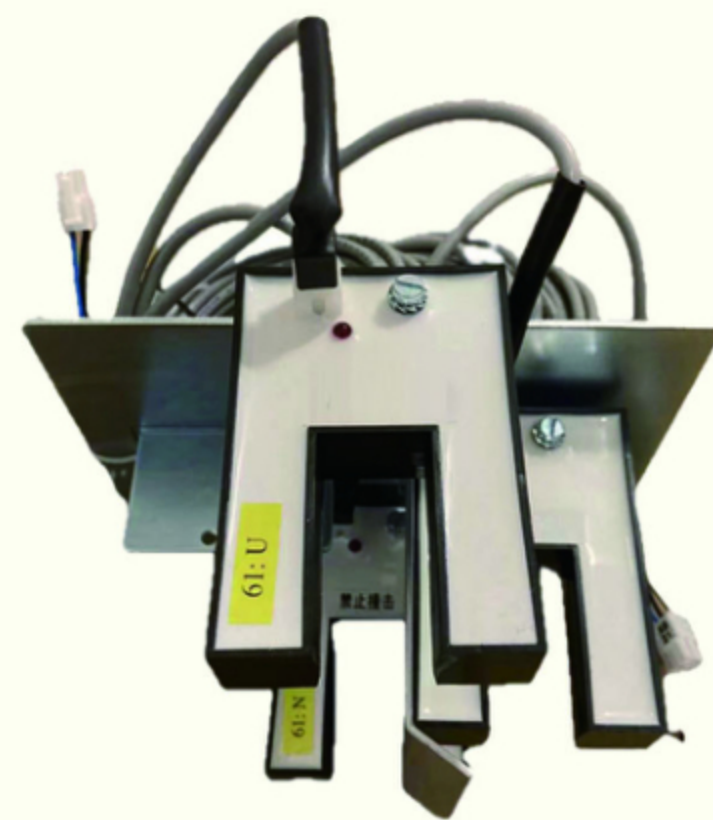

▶ SWITCH

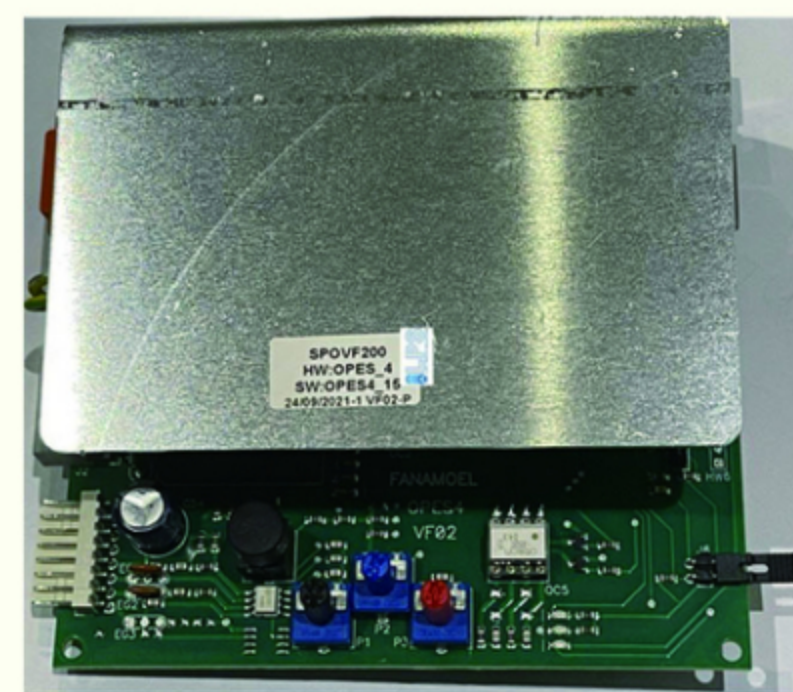

▶ OPERATOR PLATE

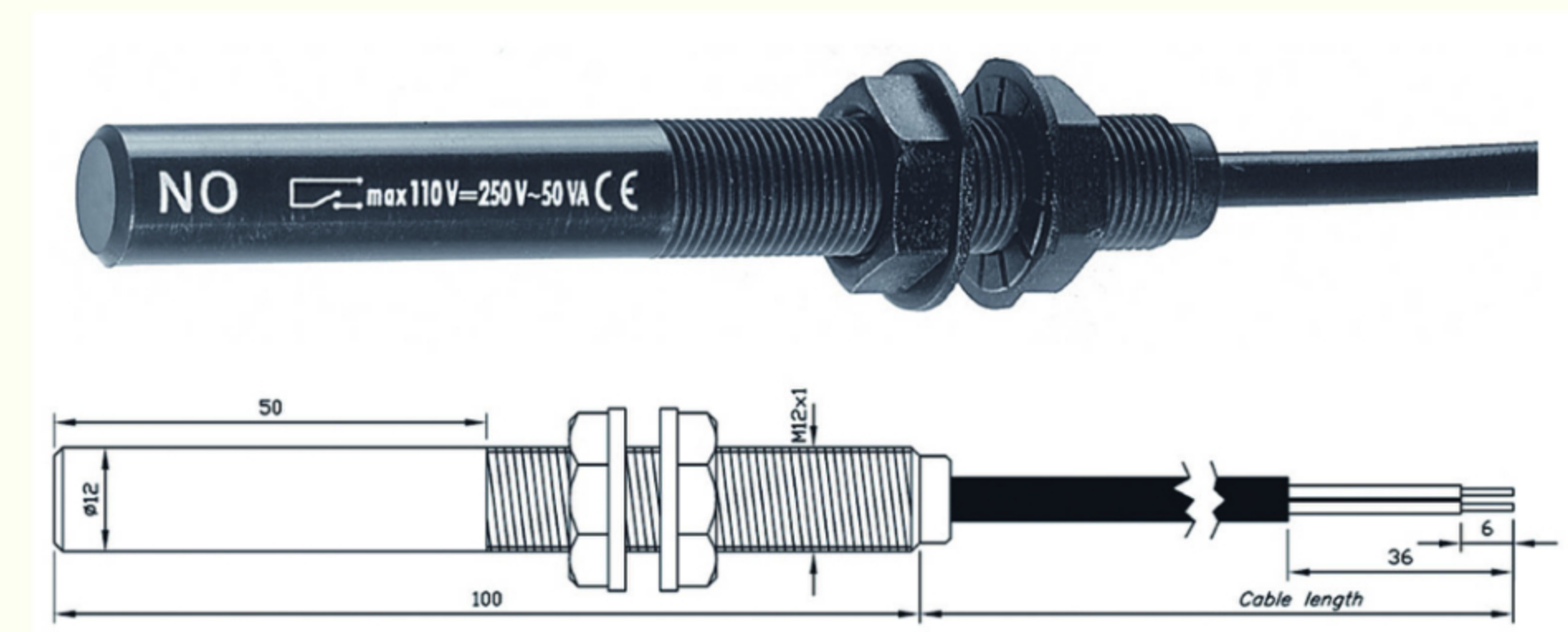

▶ MAGNETIC SENSOR



▶ TYPICAL PROJECT



GANZHOU GRAND THEATER

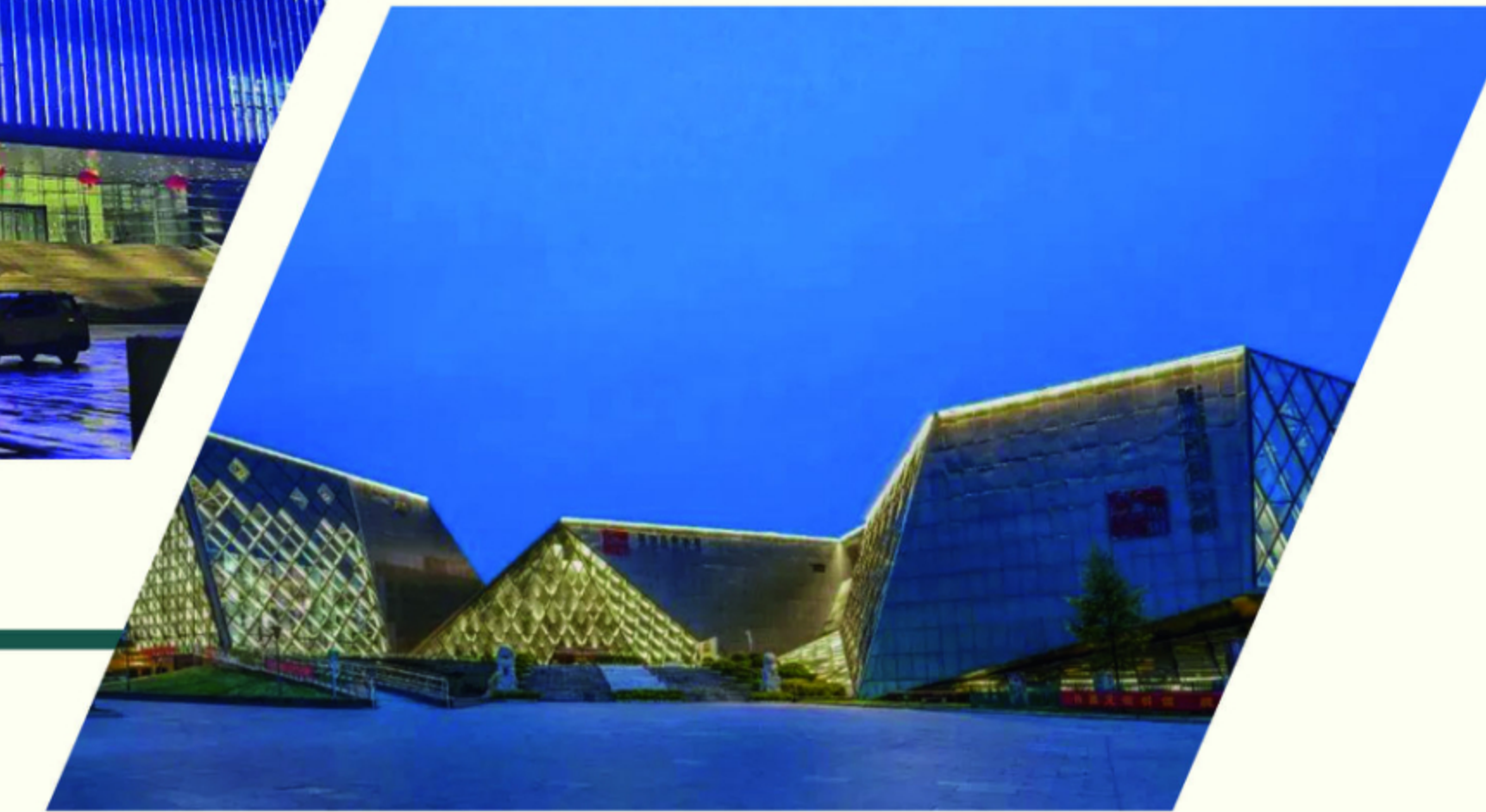

GANZHOU MUSEUM



BINJIANG INTERNATIONAL GARDEN CITY



GANZHOU GOLDEN AIRPORT

TYPICAL PROJECT



MUNICIPAL PARTY COMMITTEE AND GOVERNMENT



JI'AN GRAN YUNTIAN



XINGGUO SHANGSHANRUOSHUI



JI'AN AQUARIUM



GANJIANG INNOVATION RESEARCH INSTITUTE, CHINESE ACADEMY OF SCIENCES



XINFENG GRAND CLOUD HOTEL



ZHONGSHU CULTURE AND TOURISM



XINGGUO HENGYANG JIANGDONG PREFECTURE



- 1. NANKANG URBAN COMMERCIAL CENTER
- 2. NANKANG JIAXING CLOUD MANSION
- 3. EURO CITY
- 4. QINGFENG MEDICINE VALLEY
- 5. JINXIU TIANCHENG
- 6. JIULIFENG MOUNTAIN
- 7. JIULI BLUE BAY
- 8. NANGONG CAUSEWAY BAY
- 9. HUICHANG WEALTH PORT
- 10. HUIMIN HOSPITAL
- 11. JI'AN JINGGANGSHAN CADRE COLLEGE

▶ TYPICAL PROJECT



FENGGANG JIAYUAN RESIDENTIAL COMMUNITY IN GANZHOU HIGH SPEED RAILWAY NEW AREA



GANZHOU JINJIANG INTERNATIONAL



GANZHOU PEOPLE'S HOSPITAL SOUTH BRANCH



1



2



6



3



4



5

1. GANZHOU PEOPLE'S HOSPITAL SOUTH BRANCH GANZHOU JIULI FENGSAN LUHU COURTYARD
2. CAUSEWAY BAY, NANXIAN COUNTY, HUNAN PROVINCE
3. GANZHOU WENQING EXPERIMENTAL INTERNATIONAL SCHOOL
4. GANZHOU ZHONGCHUANG INTERNATIONAL CITY
5. HETANG NEW CITY
6. GANZHOU COMPREHENSIVE CULTURAL AND ART MUSEUM